

Esperia®

ESV 03 / 13

**The Interface between
Packaging Machine
and Weigh Price Labeller**

ESV 03 ESV 13

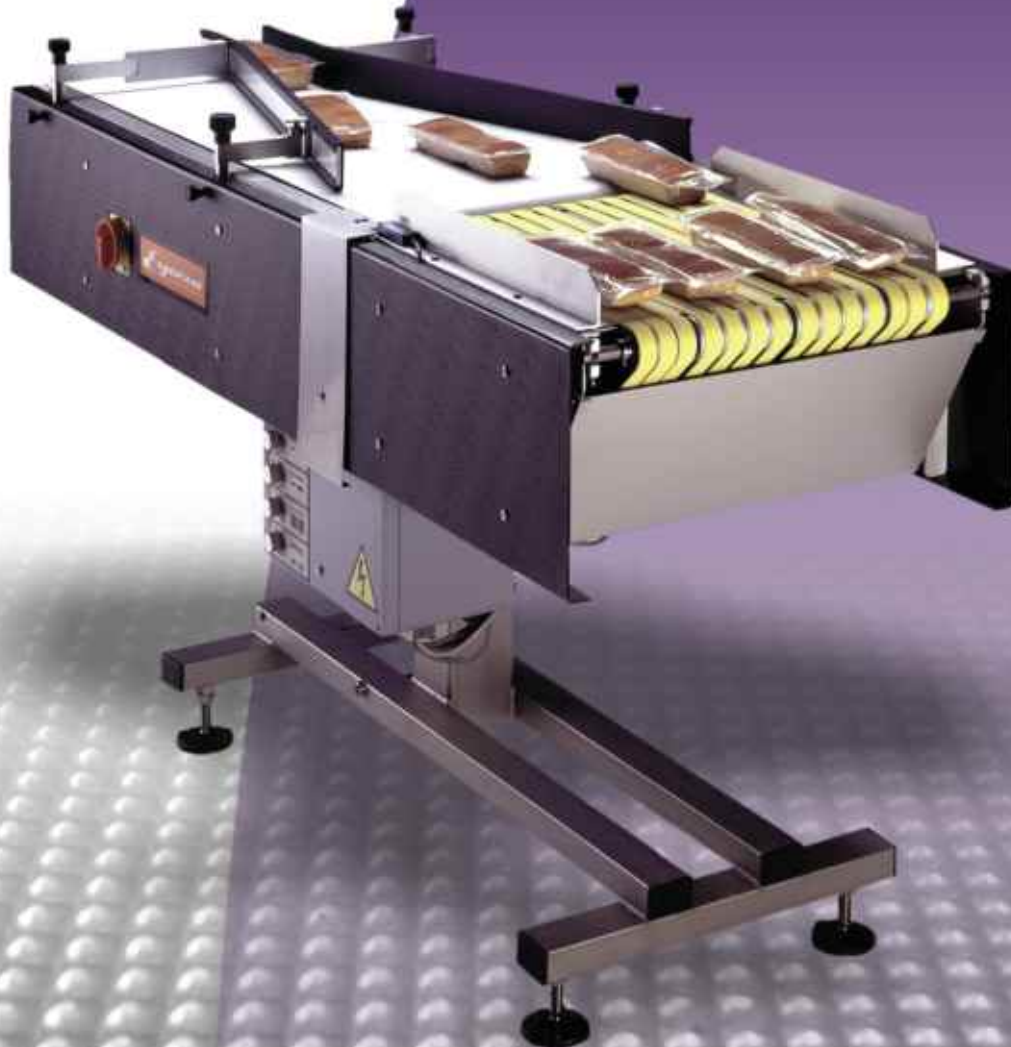



The flexible feed belt control merges up to 6 lanes at the same time

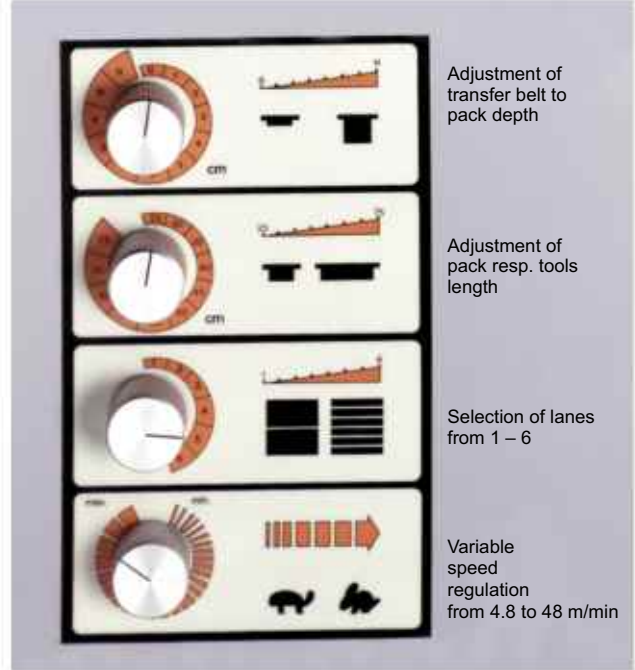

Adjustment of transfer belt to pack depth

Adjustment of pack resp. tools length

Selection of lanes from 1 – 6

Variable speed regulation from 4.8 to 48 m/min

Controller for ESV



ESPERA-WERKE GMBH
 Postfach 10 04 55
 D-47004 Duisburg
 Tel. ++49(0)203/30 54 - 0
 Fax ++49(0)203/30 54 - 275
 info@espera.com
 www.espera.com

ESV QUOTATION

To:
ESPERA-WERKE GMBH
 - Abt. Marketing -
 Postfach 10 04 55

 D-47004 Duisburg

From:

 Company

 Contact

 Address / Town

 Postcode

 Telephone

 Fax

 Date/Signature

Please send us a quotation.

In order to quote the optimal machine, please fill in the following data:

PACKING MACHINE

 Manufacturer

 Model

INFORMATION ON PACKING LINE

Outfeed conveyor existing Y N

Height of outfeed conveyor from _____ to _____

Conveyor drive continuous in cycles

Outfeed speed in m/min

CUT FOIL WIDTH

				Tick Box:
ESV 03	A	370	- 404 mm	<input type="checkbox"/>
	B	404	- 425 mm	<input type="checkbox"/>
ESV 13	A	425	- 440 mm	<input type="checkbox"/>
	B	440	- 460 mm	<input type="checkbox"/>
	C	460	- 475 mm	<input type="checkbox"/>
	D	475	- 490 mm	<input type="checkbox"/>
	E	490	- 510 mm	<input type="checkbox"/>
	F	510	- 525 mm	<input type="checkbox"/>
	G	525	- 545 mm	<input type="checkbox"/>
	H	max. 545	- 560 mm	<input type="checkbox"/>

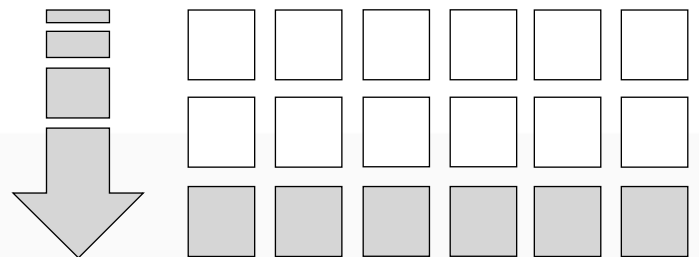
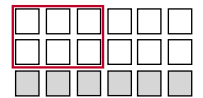

FORMAT TOOLS

Please circle the relevant tool size:
 e.g 3 tracks, double cycle



In the standard version a maximum of six adjacent tracks are possible. If the overall length (cycle) is over 450mm, a performance test with original packs is required.

PACK DATA

	Stable 	Unstable 	Other 
Please circle and enter information			
	Pack 1	Pack 2	Pack 3
Pack form	<input type="checkbox"/> <input type="checkbox"/> <input type="checkbox"/>	<input type="checkbox"/> <input type="checkbox"/> <input type="checkbox"/>	<input type="checkbox"/> <input type="checkbox"/> <input type="checkbox"/>
Length mm	<input type="text"/>	<input type="text"/>	<input type="text"/>
Width mm	<input type="text"/>	<input type="text"/>	<input type="text"/>
Height mm	<input type="text"/>	<input type="text"/>	<input type="text"/>
Weight kg	<input type="text"/>	<input type="text"/>	<input type="text"/>
Pack delivery	<input type="checkbox"/> <input type="checkbox"/> <input type="checkbox"/>	<input type="checkbox"/> <input type="checkbox"/> <input type="checkbox"/>	<input type="checkbox"/> <input type="checkbox"/> <input type="checkbox"/>
Cycles/min	<input type="text"/>	<input type="text"/>	<input type="text"/>

ESV 03

Narrow Version

Cut foil width up to 425 mm

ESV 13

Wide Version

Cut foil width from 425 mm to 560 mm

Available Adjustments

- Swivelling transfer belt for adjustment to pack depth
- Pack lengths up to 450 mm – in special cases up to 750 mm on request
- Selection of infeed from 1 - 6 lanes
- Variable speed regulation from 4.8 - 48 m/min

Mains Voltage 230V / 50 Hz safety plug
 Power Consumption 400 VA
 Operating Temperature -10°C to +40°C

The ESPERA Channelisers ESV 03 and ESV 13 can be adjusted for use between nearly any packing machine and weigh price labeller.

An optimal adjustment to existing production lines is assured by a variable speed conveyor system also above 30 m/min, an electric height adjustment to the packaging machine, flexible setting of pack lengths resp. of the single and double tools.

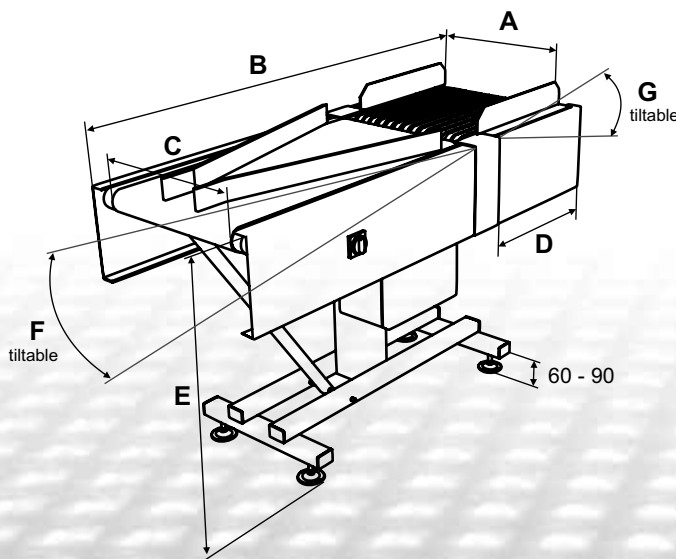

	ESV 03	ESV 13
A	370 - 425	425 - 560
B	1560	1910
C	610	760
D	550	550
E	705 - 1005	705 - 1005
F	-100 bis +200	-125 bis +250
G	-75 bis +30	-75 bis +30

all data in mm

F and G cannot be tilted to the maximum at the same time.

ESPERA-WERKE GMBH

Postfach 10 04 55 • D-47004 Duisburg

Tel. ++49(0)203/30 54 - 0 • Fax ++49(0)203/30 54 - 275

info@espera.com • www.espera.com